

maltec

GARDEN



















Tunel Foliowy Ogrodowy **Szklarnia 2,5x4x2m**

Garden Greenhouse Foil Tunnel

Gartengewächshaus Folientunnel

Spis części / Parts list / Liste der Einzelteile

NO.	1	2	3	4	5	6	7	8	9	10	11	12	13	14	15	16	
																	
	2PCS	2PCS	18PCS	6PCS	10PCS	5PCS	2PCS	10PCS	30PCS	2PCS	32PCS	1PC	1PC	4PCS	4PCS	1PC	

Uwaga:

- Prosimy dokładnie przestrzegać instrukcji montażu.
- Wspólny montaż 2-3 osób.
- Aby zapewnić maksymalną stabilność tunelu foliowego, zalecamy wykopanie rowu o średnicy 30 cm wokół podstawy tunelu foliowego i z tyłu, a następnie wypełnienie go ziemią.

Remark:

- Please carefully follow the assembly instructions.
- 2-3 persons assembly together.
- For maximum stability of your polytunnel, we recommend digging a 30cm trench around the base of the polytunnel and back, filling with soil.

Anmerkung:

- Bitte befolgen Sie sorgfältig die Montageanleitung.
- Zusammenbau mit 2-3 Personen.
- Für maximale Stabilität Ihres Folientunnels empfehlen wir, einen 30 cm breiten Graben um die Basis des Folientunnels und die Rückseite auszuheben und ihn mit Erde zu füllen.

Montaż / Installation

KROK 1 / STEP 1

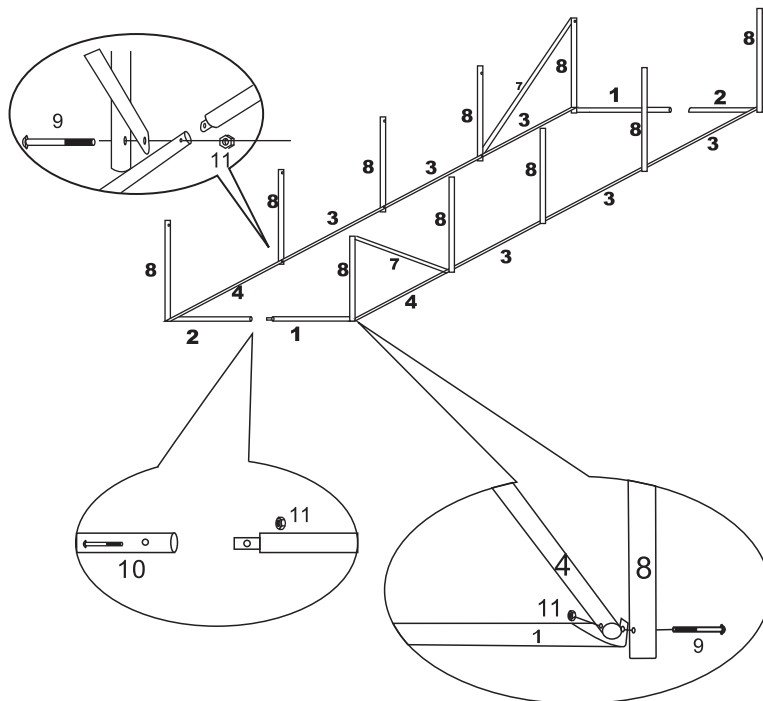

PL: Luźno zmontuj całą ramę przed dokręceniem wszystkich śrub w ostatecznym położeniu.

ENG: Loosely assemble complete frame, before tightening all bolts in final position.

DE: Montieren Sie den kompletten Rahmen locker, bevor Sie alle Schrauben in der endgültigen Position festziehen.

KROK 2 / STEP 2

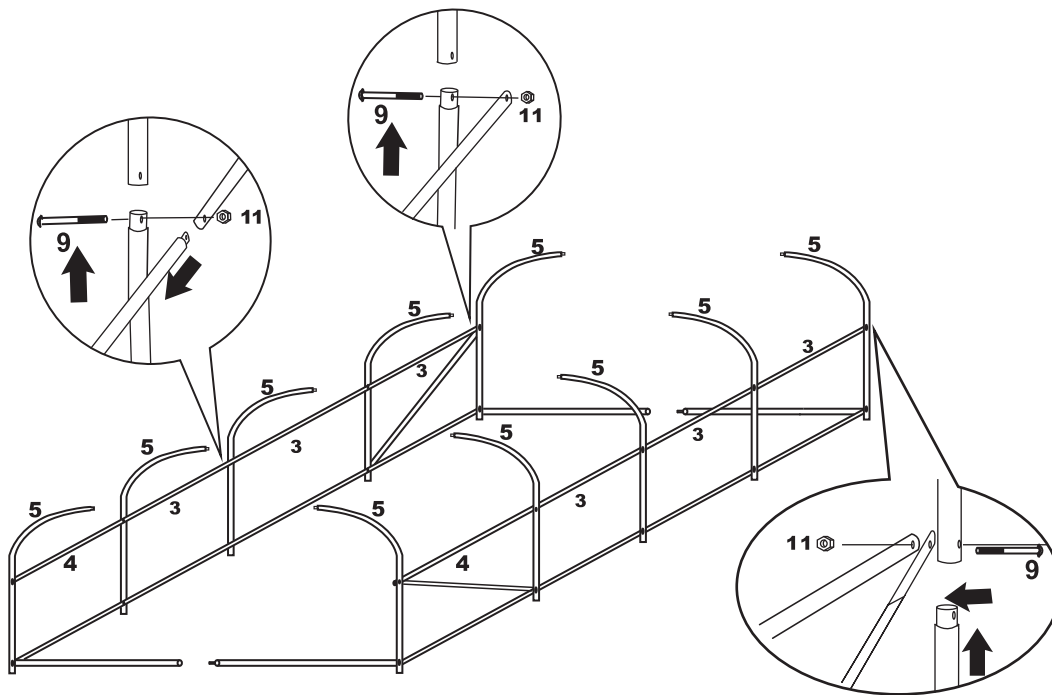

PL: Rurę nr 6 należy zamontować pomiędzy obydwoma rurami nr 5.

ENG: Tube No 6 must be assembled between both No 5.

DE: Rohr Nr. 6 muss zwischen den beiden Rohren Nr. 5 montiert werden.

KROK 3 / STEP 3

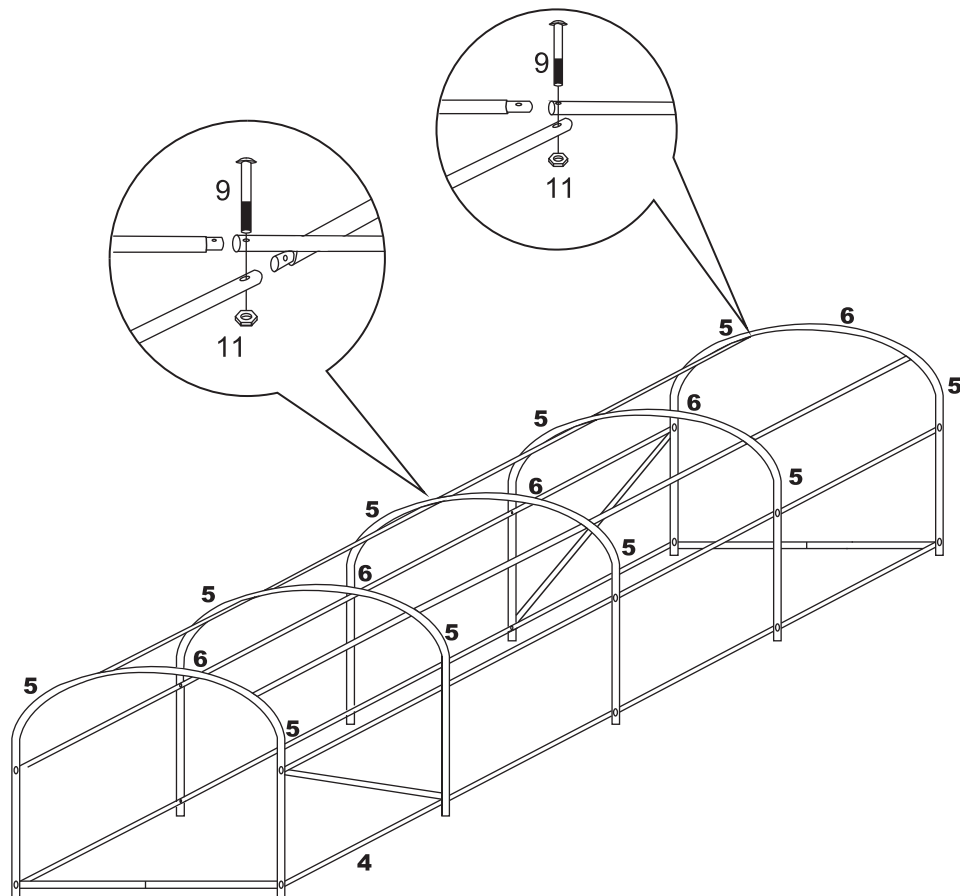

PL: Luźno zmontuj całą ramę przed dokręceniem wszystkich śrub w ostatecznym położeniu.

ENG: Loosely assemble complete frame, before tightening all bolts in final position.

DE: Montieren Sie den kompletten Rahmen locker, bevor Sie alle Schrauben in der endgültigen Position festziehen.

KROK 4 / STEP 4

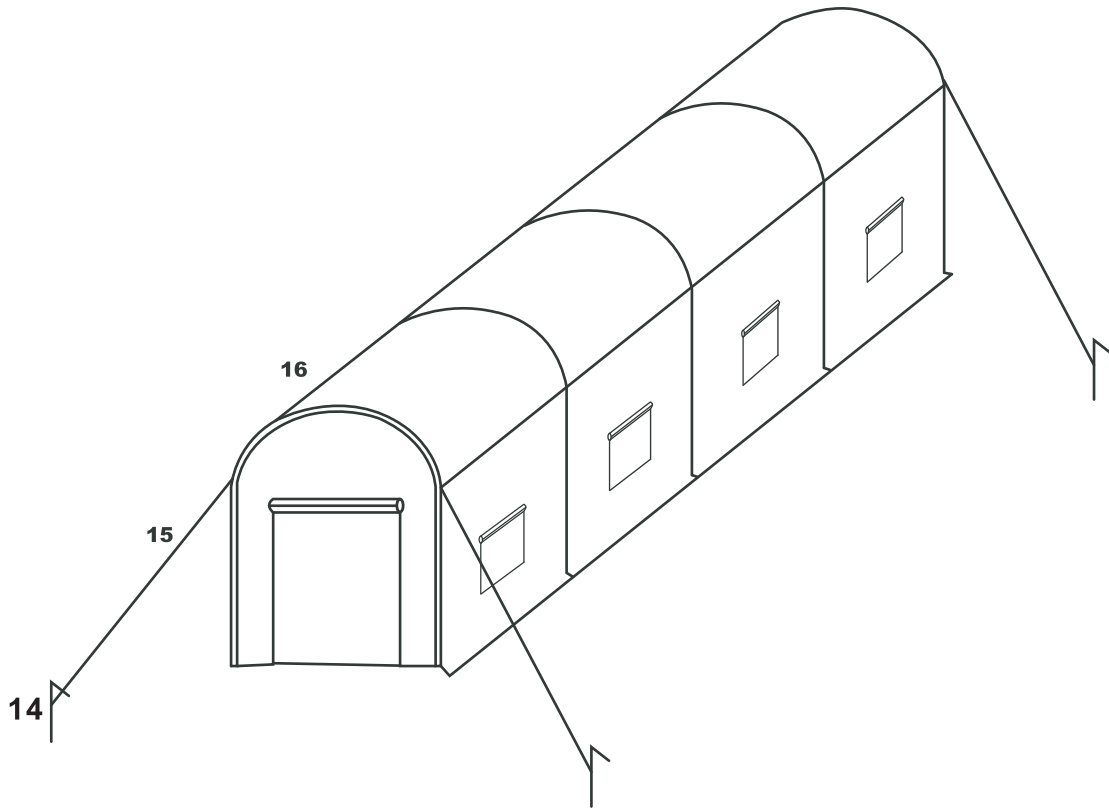

Importer:

Malis B. Machoński sp. k.
ul. Zbożowa 2E Wysogotowo
62-081 Przeźmierowo